

Article number: 203502451154ST

Description: E+G Levelling sets GN 350.2-45-11-54-ST

## Measures

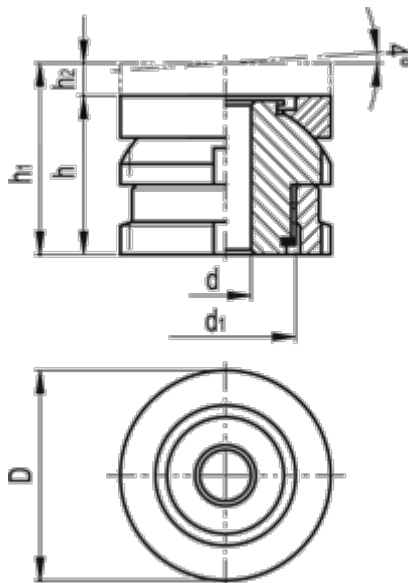

C-spanner DIN 1810 = A45-50

d = 11

D = 45

d1 = M30x1.5

For screw = M10

h = 54

h1 = 79

h2 = 25

Max static load (kN) = 84

Static preload (kN) = 64.01

Weight (g) = 553